

# Noremax Legs Mounting instructions

This is included:  
Furniture leg adapter plate  
Screws  
Bolt  
Furniture pads

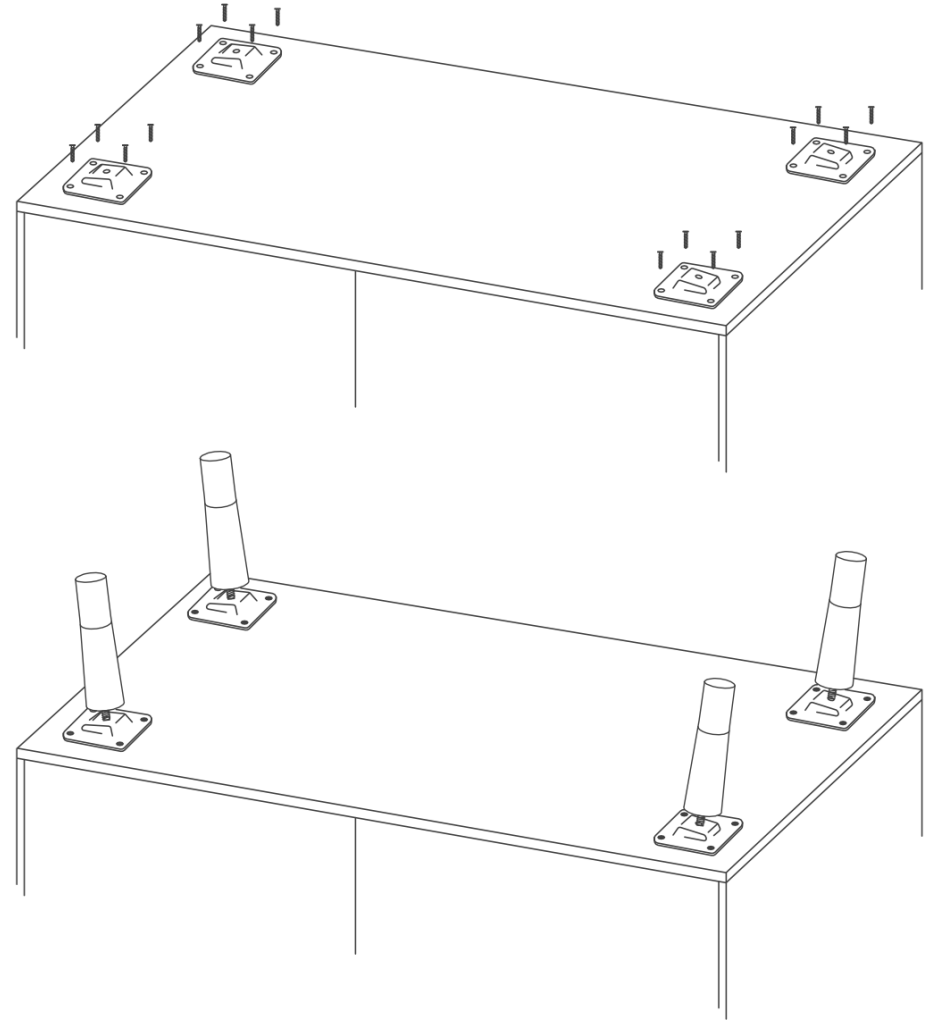
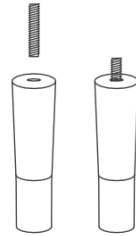
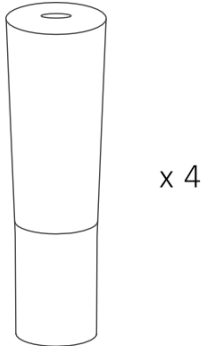
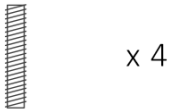
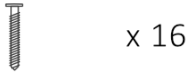
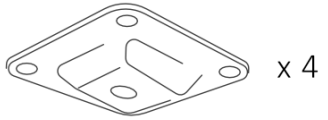

NOTE! For safety reasons, make sure to always attach your storage unit to the wall.

# NOREMAX

## Pax- Side panel Mounting instructions

Place the side panel in position.  
Note! The side is wider than the Ikea  
frame, to cover the thickness of the door  
front. Please control thickness of door  
front. The side should protrude so it's  
in line with door fronts.

Use mounting screws from the inside of  
the frame to attach the side panel. 8-10  
screws are enough.  
**IMPORTANT!** Do not screw through the  
thickness of the whole side.  
See picture below as guideline

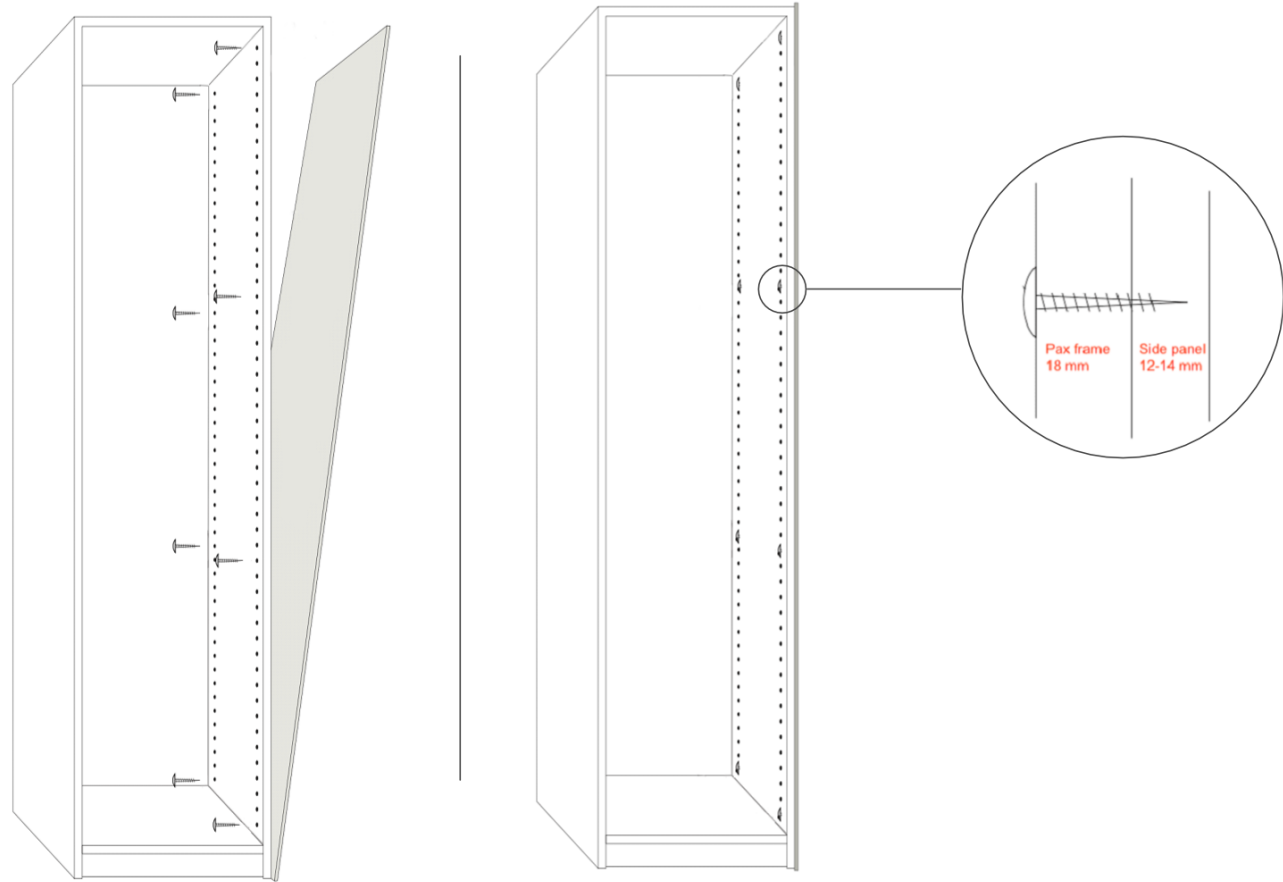

**NOTE!** For safety reasons, make sure to always attach your storage unit to the wall.

# NOREMAX

# Besta – Plinth 60,120,180 and 240cm

## Assembly instructions

This comes with:

12x screws for plinth 60 cm and 120cm width  
or  
16x screws for plinth 180 and 240cm width



8 x wooden dowels

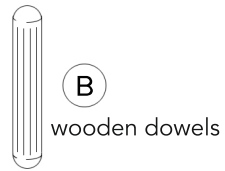

6x metal fixing bracket for plinth 60 cm and 120cm width  
or  
8x metal fixing bracket for plinth 180 and 240cm width

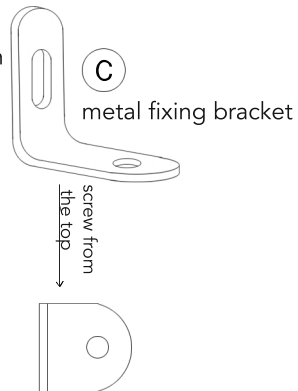

2x MDF – short side



2x MDF – long side

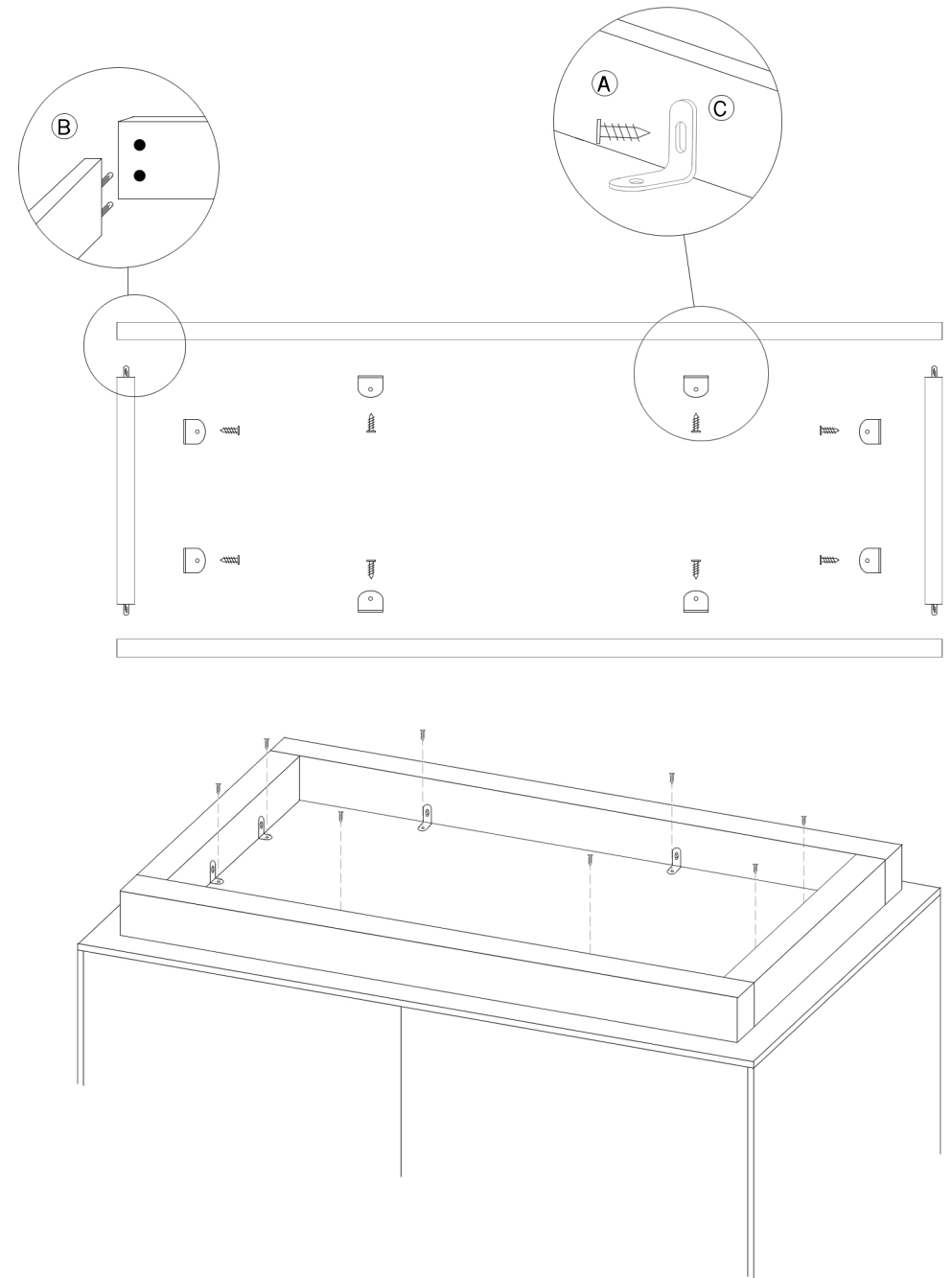
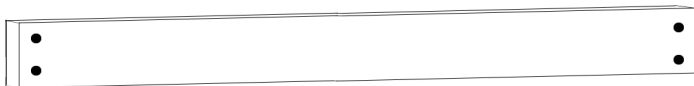

NOREMAX